

**PLEASE!! READ THESE INSTRUCTIONS!
EACH SEPARATE CONTROL YOU BOUGHT
HAS ITS OWN INSTRUCTIONS BUT
WE RECOMMEND YOU USE THESE FIRST.**



**FROM THE ORIGINATORS OF THE
PRE-HUNG AUTOMATIC GATE SYSTEM**

AMAZING GATES OF CANADA

103 Mount St. Louis Rd W

www.amazinggatesofcanada.ca

CUSTOMER SERVICE 855-484-2837 TECH SUPPORT 877-313-8902

LAYING OUT YOUR AMAZING GATE

Determine the gate location and lay it out on the ground. White spray paint or white flour work well and some stakes and a string line are helpful. Basic principles include: THE POCKET, i.e. the gate's distance from the turn into your driveway, SQUARENESS, i.e. the gate's angle to the drive path, INSWING/OUTSWING, and HANDING, i.e. which side of the gate has the hinges?

Below are drawings showing some layout scenarios. Sometimes space limitations may force you to use a less desirable layout.

THE POCKET

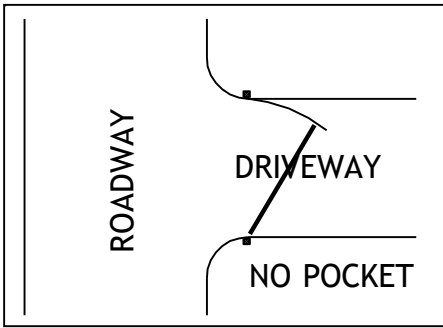

WORST CASE- PREVENTS YOU FROM PULLING OFF ROAD AS YOU WAIT FOR THE GATE. PREVENTS LARGER VEHICLES FROM MAKING THE TURN IN

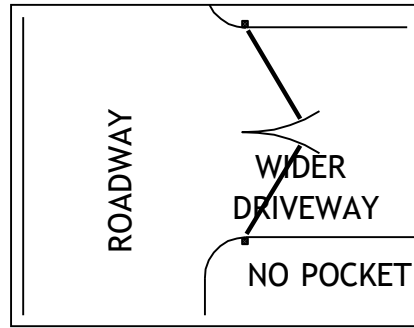

IMPROVED CASE- DOESN'T ALLOW A POCKET BUT ALLOWS LARGER VEHICLES (A MOVING VAN ETC.) TO MAKE THE TURN INTO THE DRIVEWAY

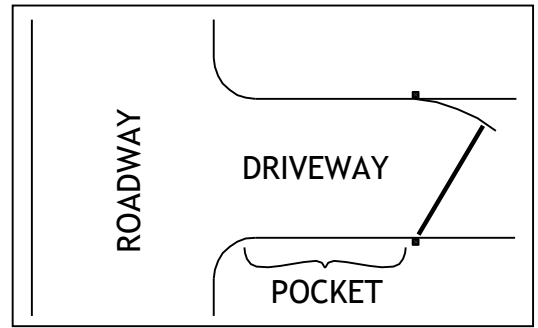

BEST CASE- LETS YOU COMPLETE THE TURN AND PULL OFF ROAD WHILE YOU WAIT FOR GATE TO OPEN

1. It is most desirable to have a slight "pocket" in front of your gate. If the gate must be right up against your road, a wider opening should be considered.

SQUARENESS

1. Since most automatic gates open only slightly more than ninety degrees, it is important to make the gate perpendicular to your drive path.

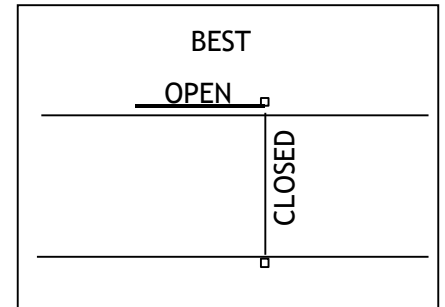
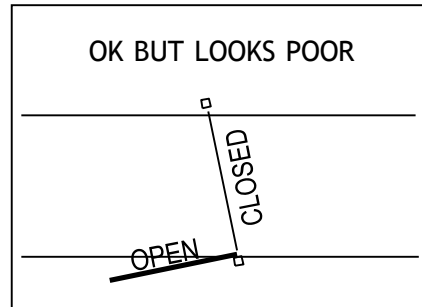
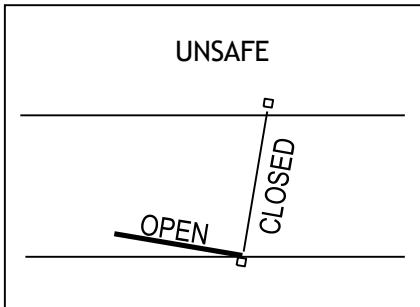

1. Curved driveways demand extra care in layout. No one wants their gate hit by a vehicle.

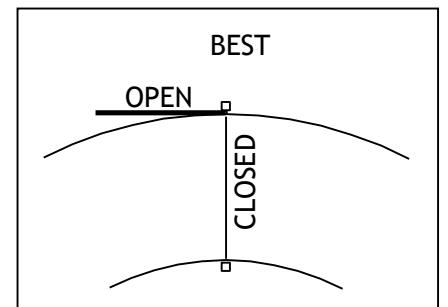
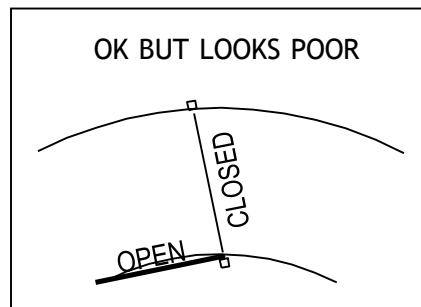
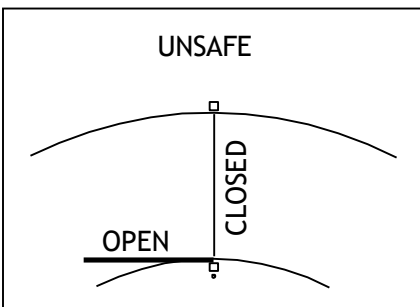

LAYING OUT YOUR AMAZING GATE

IN-SWING/OUT-SWING

1. The most desirable configuration for a swinging gate is to swing inward. However, certain driveway conditions can make it necessary to swing a gate outward.

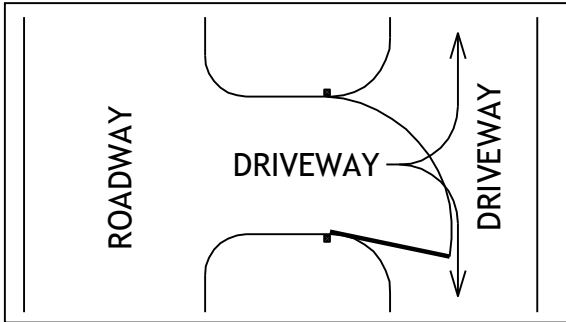

PROBLEM (AT LEFT)
WHEN OPEN, IN SWING-
ING GATE PROTRUDES
INTO DRIVE SPACE

SOLUTION (RIGHT)
CHANGE GATE TO AN
OUT-SWING

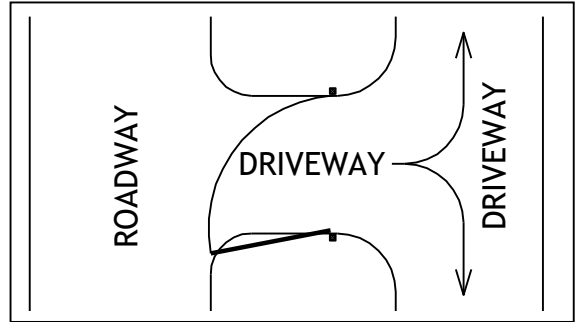

2. Another condition that may force you to swing your gate outward is an upward sloping driveway.

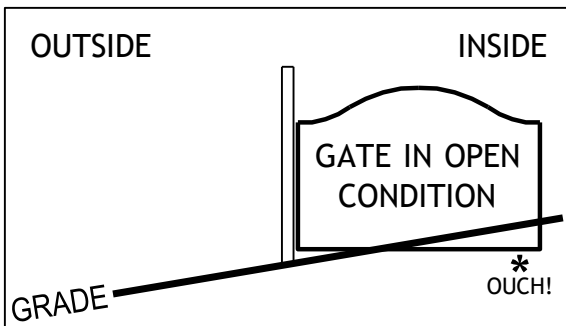

PROBLEM (AT LEFT)
WHEN IN-SWINGING GATE
OPENS, IT HITS GROUND.
YOU CAN HANG GATE
HIGHER ON THE POST BUT
MORE THAN 6"-8" ABOVE
GRADE LOOKS BAD.
SOLUTION (RIGHT)
GATE INSTALLED AS AN
OUT-SWING, PLENTY OF
GROUND CLEARANCE.

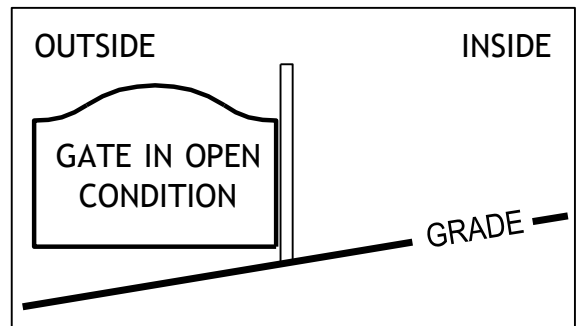

Please note that push to Open brackets are available please call customer service for details
(855) 484-2837

"HANDING" YOUR GATE

Imagine standing OUTSIDE your gate, then ask yourself "are the hinges on the right or the left?" See the four examples below.

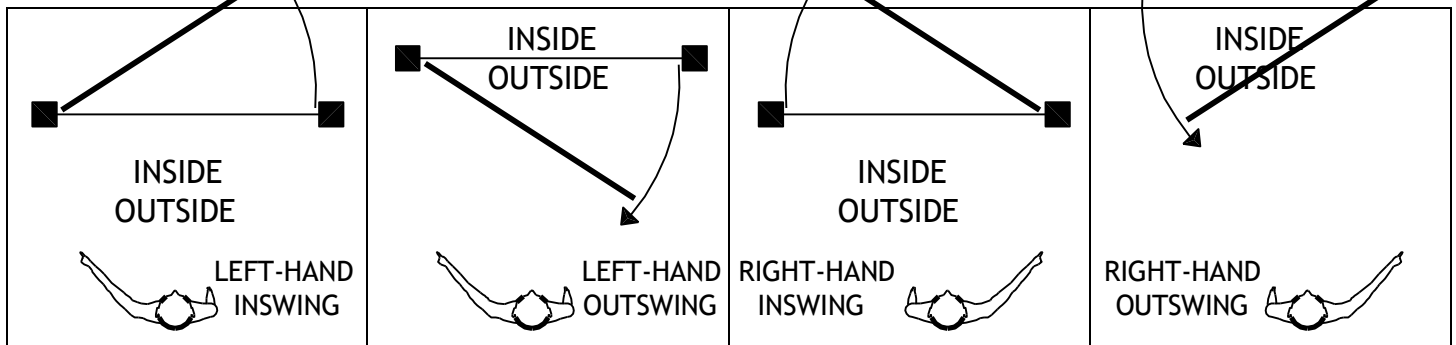

11-04-11

PAGE 2

IMPORTANT HINGE POST
INSTALLATION INFORMATION, PLEASE
READ!

BEFORE INSTALLING YOUR HINGE POSTS IN CONCRETE, PLEASE DOUBLE CHECK THE PLACEMENT OF THE INDICATING STICKER ON YOUR HINGE POSTS, THIS STICKER SHOULD MARK A LINE 38" FROM THE BOTTOM OF THE 3.5" or 5" DRIVE GATE HINGE POST AND 26 3/8" FROM THE BOTTOM OF THE 2.5" PEDESTRIAN GATE HINGE POSTS. THE STICKER INDICATING WHERE THE BOTTOM OF THE GATE WILL HANG THAT IS ON YOUR HINGE POSTS IS MEANT ONLY AS A STANDARD GUIDE AND THE BOTTOM OF THE GATE, DEPENDING ON THE STYLE YOU CHOOSE, MAY DIFFER FROM THE STICKER. ALSO, SOMETIMES THE STICKER CAN MOVE DUE TO HEAT OR MOISTURE OR BE MIS-PLACED DUE TO HUMAN ERROR. AS THE POSITION OF THE HINGE POST IS CRITICAL TO ENSURING PROPER INSTALLATION, ALWAYS DOUBLE CHECK BEFORE POURING CONCRETE TO ENSURE YOUR GATE WILL HANG AT THE DESIRED HEIGHT, GENERALLY BETWEEN 2-4" ABOVE GRADE.

Thank you for your purchase!

Amazing Gates of Canada

DRIVE GATES

SETTING THE POSTS

YOU WILL NEED:

1. STRING LINE AND LINE LEVEL
2. SHOVEL/POST HOLE DIGGERS/DIGGING BAR
3. TAPE MEASURE AND A LEVEL
4. HAMMER AND STAKES
5. WHEELBARROW
6. PRE-MIXED CONCRETE (APPROX. 8-10 60 LB. OR 6-8 80 LB. SACKS)

- 3 ALIGN THE INDICATING STICKER ON THE POST WITH THE LEVEL STRING

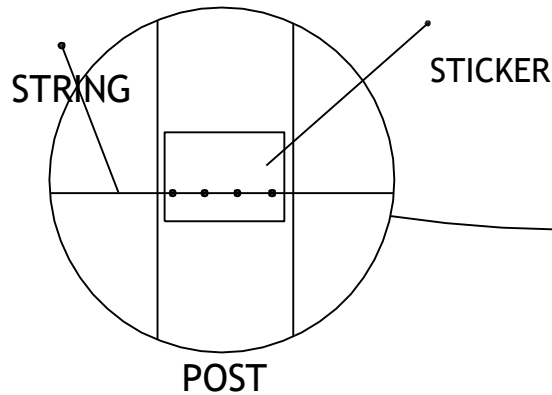

NOTE: ALWAYS DOUBLE CHECK THE POSITION OF THE STICKER WITH A TAPE MEASURE AS STICKER CAN MOVE OR BE PLACED INCORRECTLY. MARKS ON THE STICKER SHOULD BE 38" FROM THE BOTTOM OF THE STANDARD 8'-4" HINGE POST.

4

SET THE POSTS IN CONCRETE, HOLE DIAMETER SHOULD BE AT APPROX. 16". DO NOT MAKE HOLE PERFECTLY ROUND. MIX CONCRETE STIFF SO THE POST WILL STAND UNAIDED UNTIL CONCRETE SETS (24 HOURS).

- 2 USE A LINE-LEVEL ON THE STRING OR A LASER LEVEL. SET THE STRING WHERE YOU WANT THE BOTTOM OF THE GATE WHEN IT IS CLOSED.

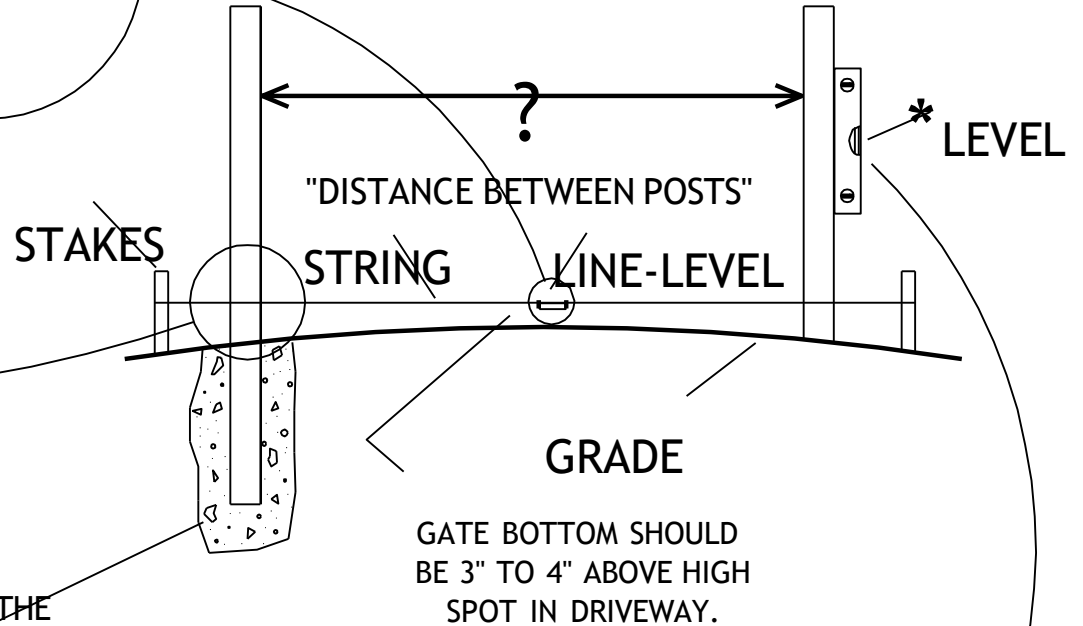
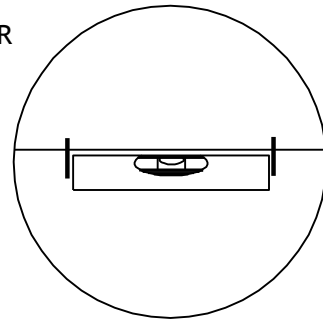

? "DISTANCE BETWEEN POSTS" IS THE NOMINAL WIDTH OF YOUR GATE, I.E. IF YOU BOUGHT A 16 FOOT GATE, SET THE POSTS EXACTLY 16 FEET APART, 12 FOOT GATE, 12 FEET APART ETC.

- 5 USE THE LEVEL TO PLUMB THE POSTS IN BOTH DIRECTIONS

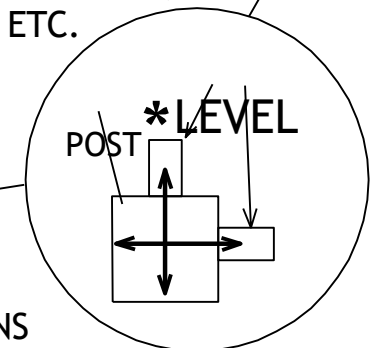

HANGING THE GATE

We will illustrate a single swing gate. A dual or bi-parting simply has a second hinge post in lieu of a strike post

BESIDES THE EQUIPMENT WE SHIPPED TO YOU, YOU WILL NEED: 1. 2 crescent wrenches 2. screwdrivers 3. a level 4. Some all-weather grease 5. A helper

1 PREP HINGES

Using the supplied machine screws bolt the hinge barrel assemblies to the posts. Do NOT over-tighten these bolts, 20 foot pounds is the maximum recommended. The other half of each hinge, the hinge-pin, bolts through the $\frac{3}{4}$ inch holes in the gate itself. Each hinge-barrel takes a ball bearing and a hinge-pin. Using an all-weather grease, put a dollop on each ball bearing and insert a bearing into each barrel.

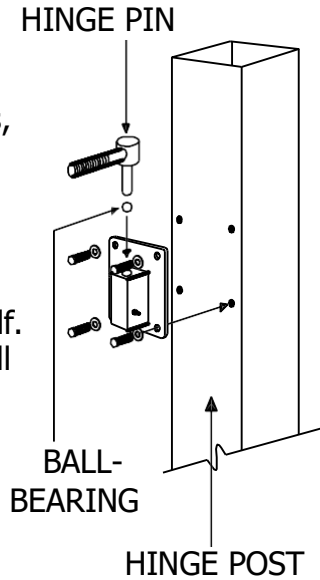

2 PREP HINGE-PINS

Next, put the threaded portion of the hinge-pins through the holes in the gate frame, tighten lightly with a wrench, making sure the unthreaded portion points down and is parallel to the gate frame.

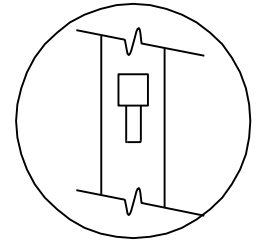
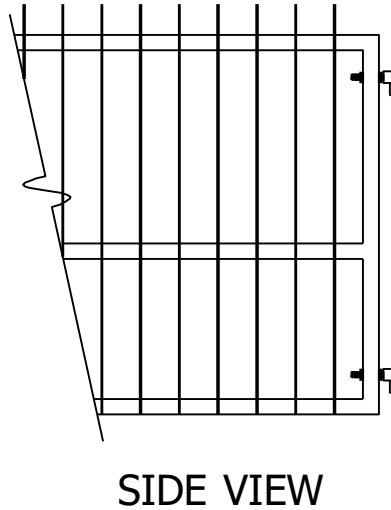

HINGE
DETAIL
END VIEW

3 HANG THE GATE

Using a helper, lift the gate and gently slide it toward and down onto the hinge barrels. This may take two or three attempts since both hinge-pins must enter the barrels simultaneously.

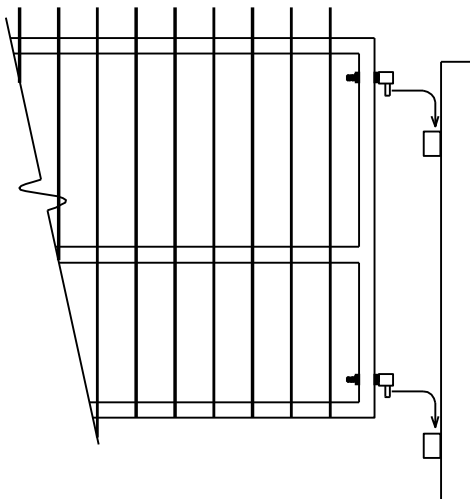

4 LEVEL AND TIGHTEN

Finally, using your level and the crescent wrenches, adjust the top and bottom hinge-pins with the nuts until the gate hangs exactly level. Check the swing, it should be smooth and quiet. Tighten the hinge-nuts completely.

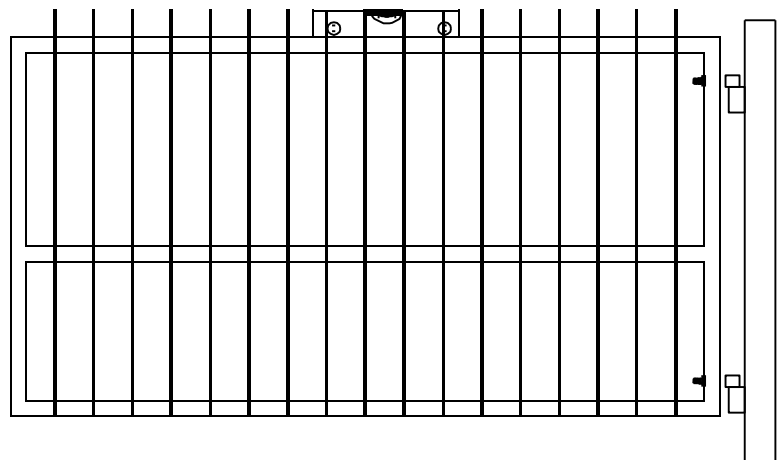

DRIVE SURFACE

DRIVE SURFACE



Amazing Gates of Canada

Instructions for attaching finials

Encircle inside the base of the finial (spear, ball or flat cap) with a continuous bead of silicone. **Note:** Only a small amount of silicone is needed. Excess may form at the base when fitted over the picket. The excess can be removed by wiping with a damp cloth.

The finials should fit snug over the pickets. If a finial does not readily fit over the picket, drive the finial on using a rubber mallet. ***CAUTION*** the finials are made of aluminum; therefore make sure to use only a light amount of force. If you continue to have problems fitting the finial onto the picket, lightly sand down the powder coat finish at the top of the picket. Continue to lightly sand until the final fits.

If these methods do not resolve the problem, please contact our Customer Service Department at: 855-484-2837